

UHF communications with CubeL: the path to nominal operations

Pierre-Alexis Lagadrillière^{a*}, Arvind Balan^b, Kay Müller^c, Felix Huber^d

^a *Communication and Ground Stations, German Space Operations Center, German Aerospace Center (DLR), Oberpfaffenhofen, 82234 Wessling, Germany, pierre.lagadrilliere@dlr.de*

^b *Mission Operations, German Space Operations Center, German Aerospace Center (DLR), Oberpfaffenhofen, 82234 Wessling, Germany, arvind.balan@dlr.de*

^c *Communication and Ground Stations, German Space Operations Center, German Aerospace Center (DLR), Oberpfaffenhofen, 82234 Wessling, Germany, kay.mueller@dlr.de*

^d *Director Space Operations and Astronaut Training, German Space Operations Center, German Aerospace Center (DLR), Oberpfaffenhofen, 82234 Wessling, Germany, felix.huber@dlr.de*

* Corresponding Author

Abstract

CubeL (aka PIXL 1) is a 3U cubesat serving in-orbit-demonstration purposes. Its main payload is OSIRIS, a miniaturized optical terminal designed by DLR and Tesat-Spacecom which is capable of transmitting up to 100Mbps. CubeL is also the first COTS cubesat operated by the German Space Operations Center (GSOC). For this, a standard UHF transceiver using CSP, the Cubesat Space Protocol, has been installed on the spacecraft. And a brand new UHF ground station was installed on GSOC's roof in Oberpfaffenhofen, Germany. The UHF station consists of a steerable double cross Yagi antenna linked to a transceiver of the same design as the one on board the spacecraft. This transceiver also relies on CSP and secures the compatibility between spacecraft and ground station. After introducing the CubeL spacecraft, its on-board UHF communication systems, and the new UHF ground station, we will present the challenges encountered by GSOC to operate CubeL with the UHF link. Among others, we will detail how the geometry of the ground antenna and various misalignments affect the link quality and what this means for daily operations. Effects of phase misalignment on the antenna and their impact will be detailed too. And the consequences of the World Radiocommunication Conference 2019 (WRC-2019), more specifically the addition of the article 5.264A, on operations with the UHF communication link will be analysed in detail. GSOC's strategy to tackle those obstacles and restore nominal operations with CubeL will be described. To conclude, we will discuss if this UHF link is viable in today's conditions.

Keywords: DLR, GSOC, CubeL, UHF, CSP , WRC-2019

Acronyms/Abbreviations

Commercial Off-The-Shelf (COTS)
Cubesat Space Protocol (CSP)
Equivalent Isotropic Radiative Power (EIRP)
German Aerospace Center (DLR)
German Space Operations Center (GSOC)
Graphic User Interface (GUI)
In-Orbit-Testing (IOT)
Institute of Communications and Navigation (IKN)
Launch and Early Orbit Phase (LEOP)
Low Earth Orbit (LEO)
Radio Frequency compatibility Test (RFCT)
Ultra High Frequencies (UHF)
World Radiocommunication Conference 2019 (WRC-2019)

1. Introduction

The CubeL mission, also known as PIXL-1 and as OSIRIS4Cubesat, is a cooperation between the Institute of Communications and Navigation (IKN) of the German Aerospace Center (DLR) and the company Tesat-Spacecom, where the DLR German Space Operations Center (GSOC) supports the spacecraft operations. Numerous Cubesat missions rely on Ultra High Frequency (UHF) communications and Cubesat Space Protocol (CSP). This is the case for CubeL, which uses UHF and CSP for its main communication link. In addition, an S-band transceiver is installed on board as a secondary payload with the aim to test and validate on cubesats S-band communication using CCSDS protocols.

For CubeL operations, GSOC purchased a brand-new UHF station from the same manufacturer as the spacecraft and installed this station at the GSOC premises in Oberpfaffenhofen. The objectives of GSOC were to operate CubeL and to gain experience with CSP and UHF systems. The path towards these objectives happened to be more eventful than expected. In order to establish UHF communications, the link had to be analysed in detail, some methods requiring to be developed first. Following this, the ground station was analysed in depth too before applying modifications to the systems.

We will first introduce CubeL and the UHF ground station in chapters 2 and 3. In the following chapter we will dive into the impairments of the UHF link and the methods used to identify and mitigate the problems. After that, we will discuss the impact of WRC-2019 and the physical issues of the ground station before summarizing in chapter 5 the lessons learned from the challenges imposed by WRC-2019 and from the issues encountered. In regard of the actions taken and the lessons learned, we will conclude on the viability of the CubeL UHF link.

2. CubeL mission

CubeL was launched in January 2021 as part of a SpaceX launch into a Sun-Synchronous Orbit (SSO) at an altitude of 560 km and an inclination of 97.6°. The mission is designed for a duration of 3 years. The satellite is built on top of a 3U CubeSat platform, which hosts the payload as well as necessary space to ground interface infrastructure. An overview of the satellite's subsystems is shown in Fig. 1. The primary payload of the satellite is a miniaturized laser terminal *OSIRIS4CubeSat*. Additional payload consists of components required for the S-Band link.

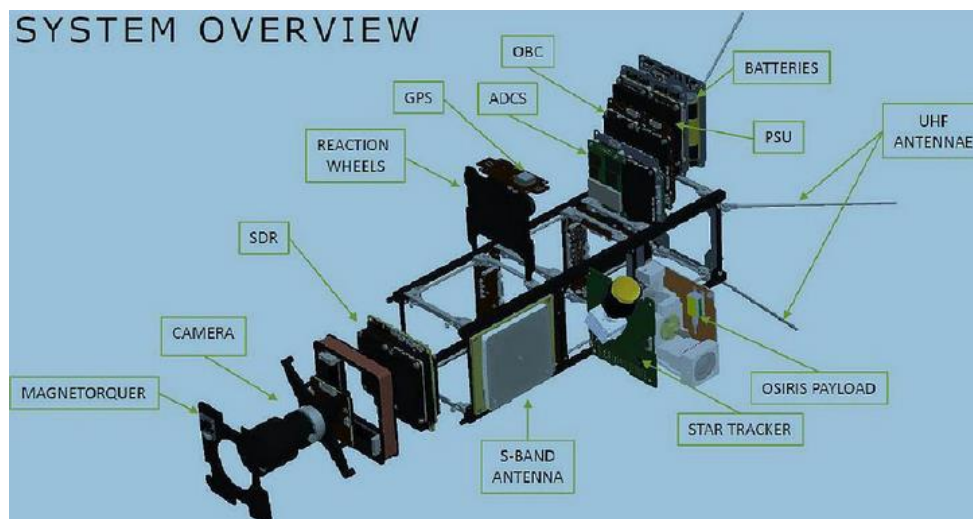

Fig. 1 CubeL System Overview [1]

The primary mission objective of CubeL “is the successful in-orbit demonstration (IOD) of the OSIRIS4CubeSat module's downlink capabilities and reliability” [1]. The secondary mission objective is to integrate CubeL into the existing multi mission command and control infrastructure of GSOC. GSOC will take over routine operations with the satellite manufacturer performing the Launch and Early Orbit phase (LEOP) including the In-Orbit-Testing (IOT).

CubeL will be monitored and controlled via UHF using a compatible COTS ground segment [2]. The UHF link for CubeL, in contrast to the typical mission control systems used at GSOC, is operated using the CSP. It functions as an interface between multiple nodes representing satellite or ground components, each of which can communicate with each other if configured appropriately. Commanding is done from a terminal (csp-term) using a shared set of commands that are understood by each node (if the respective software is present).

3. UHF ground station

DLR purchased a UHF ground station from GOMspace along with the CubeL spacecraft. This ground station consists in 3 main components: the antenna system (AS100), the ground station radio (GS100) and the mission control computer (MS100), as seen in Fig. 2.

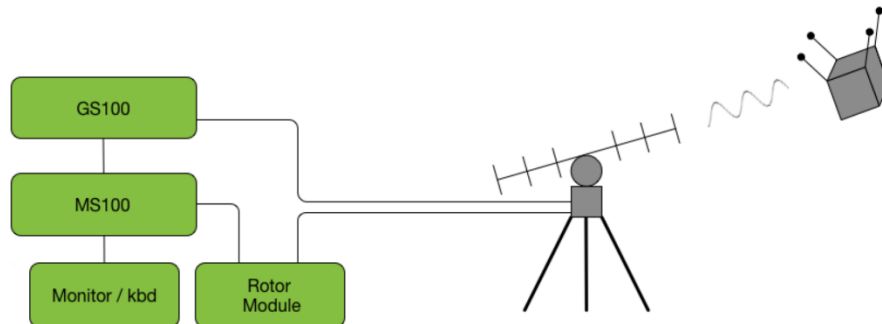

Fig. 2 GOMspace UHF ground station components [3]

3.1 AS100 [3]

The AS100 furnished by GOMspace is an outdoor antenna system designed for UHF communications with spacecrafts located on Low Earth Orbit (LEO). It consists of a mast on which are mounted two cross Yagi antennas. These two antennas are installed parallel to each other and are steerable in azimuth and elevation through two motors operated by a rotor controller. Also, both antennas are equipped with 2 receiving/transmitting dipoles perpendicular to each other.

To steer this antenna, an indoor rotor controller is connected from one side to the azimuth and elevation motors, and from the other side to the tracking system.



Fig. 3 AS100 at GSOC in Oberpfaffenhofen (on a day with Scirocco)

As a result, the current DLR system achieves a beamwidth of 14° and a gain in downlink of approximately 18 dBi, as can be seen in Table 1 below. And depending on how the dipoles are connected, it is possible to receive and transmit signals with vertical, horizontal, left-hand circular or right-hand circular polarization.

Description	Value	Unit
Frequency range	400	MHz
Beam-width	14	°
Gain	18	dBi
LNA gain	20	dB

Table 1 AS100 Antenna parameters

3.2 GS100 [4] [5]

The NanoCom GS100 is a ground station radio. It receives the satellite downlink signals via the AS100, extracts the CSP packets from the satellite downlink signal and forwards these packets to the MS100 for further processing and storage. In parallel, it transmits an uplink signal to the satellite based on the CSP packets received from the MS100. The GS100 is also integrated in the CSP network, meaning it is a node like any other ground or on-board component within this network. Thus, the satellite monitoring and configuration software running on the MS100 is also able to control the GS100, which simplifies its configuration process.

The architecture of the GS100 is rather simple and relies on two NanoCom AX100 and one 25W power amplifier, as we can see in Fig. 4. The AX100 are long-range half-duplex software-configurable UHF transceivers. These transceivers are basically demodulating downlink signals into CSP packets and modulating CSP packets into uplink signals, yet not at the same time as these are working in half-duplex, meaning that these transceivers can only execute one activity at a time between transmitting and receiving signals. An additional specificity of the GS100 is that one AX100 is connected to the vertically polarized channel and the second AX100 to the horizontally polarized channel, thus allowing the GS100 to have full polarization diversity (all polarization types can be supported). It is important to add that the AX100 are not only inside the GS100 but also on board CubeL, yet with one difference being their qualification. For obvious monetary reasons, the AX100 inside the GS100 are not flight proven, whereas the ones on board CubeL are. That being said, using the same hardware base presents many advantages like reduced development costs and lowered risks. As for the 25W power amplifier, this component amplifies the output signal to 14dBW and leads to an Equivalent Isotropic Radiative Power (EIRP) of 29dBW for the ground station.

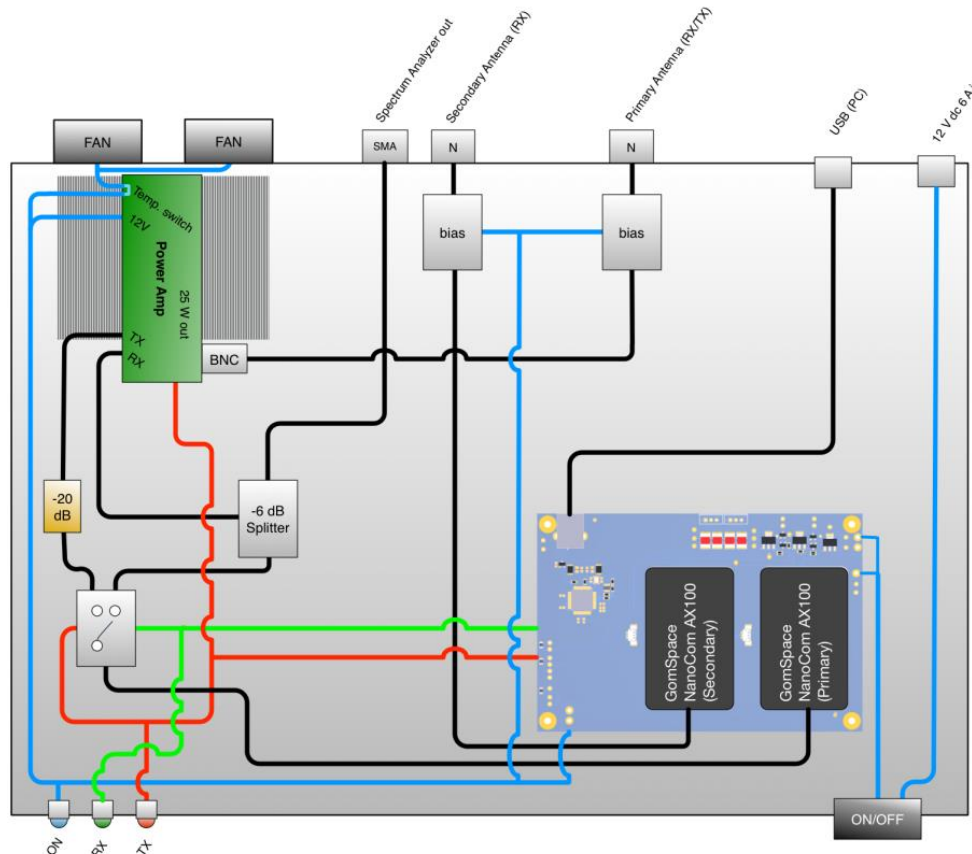

Fig. 4 GS100 block diagram [4]

3.3 MS100 [6]

The MS100 contains the brain of the ground station and is based on a standard 19” rack computer running on Linux. Its main purposes are to:

- interface with the rotor controller via a daemon, and consequently drive the antenna
- host csp-term, a terminal based on the CSP which enables the main operations of CubeL
- host csp-doppler, the CSP based terminal responsible for predicting satellite trajectories, tracking the satellites and compensating Doppler effects
- parse the telemetry packets arriving from the satellite
- link the satellite systems to the ground station using a CSP network
- offer a database for telemetry and configurations
- host a web based Graphic User Interface (GUI) to display the telemetry.

All these purposes are necessary to execute the satellite mission. AS100, GS100 and MS100 form together the complete ground station. This architecture relies mostly on Commercial Off-The-Shelf (COTS) components, with the clear advantage of keeping prices low compared to conventional ground station like for S-band communication.

4. Establishing UHF communications

UHF is the main communication system with CubeL. This means that data like files, flight plans, software updates should transit via this UHF channel. Unfortunately, several issues were encountered over the last 2 years, which impacted in more or less severe ways the UHF communications. We will detail here these issues and our bumpy way to a (un-)stable UHF link with CubeL

For CubeL, UHF communications correspond to the following:

- Uplink between 401,2 and 401,3 MHz
- Downlink between 400,15 and 401 MHz

4.1 The world before and after World Radiocommunication Conference 2019 (WRC-2019)

4.1.1 WRC-2019 article 5.264A

During the World Radiocommunication Conference 2019 (WRC-2019), an article was added to limit the EIRP of the UHF earth stations. WRC-2019 states [7]:

ADD 5.264A

In the frequency band 401-403 MHz, (...) the maximum e.i.r.p. of any emission of each earth station in the meteorological-satellite service and the Earth exploration-satellite service shall not exceed 7 dBW in any 4 kHz band for non-geostationary-satellite systems with an orbit of apogee lower than 35 786 km.(...) The maximum e.i.r.p. of each earth station in the meteorological-satellite service and the Earth exploration-satellite service shall not exceed 7 dBW for non-geostationary-satellite systems with an orbit of apogee lower than 35 786 km in the whole 401-403 MHz frequency band. Until 22 November 2029, these limits shall not apply to satellite systems for which complete notification information has been received by the Radiocommunication Bureau by 22 November 2019 and that have been brought into use by that date. After 22 November 2029, these limits shall apply to all systems within the meteorological-satellite service and the Earth exploration-satellite service operating in this frequency band.

4.1.2 Consequences and ways forward for CubeL

This WRC-2019 article impacted tremendously the communications in UHF between our ground station and CubeL. In fact, if downlink remained untouched, our ground station uplink, with an original EIRP of 29 dBW, had to be choked down to an EIRP of 7dBW. The main question at this point was: how to establish an uplink despite the 22dB lower uplink? When it is vital to compensate a lowered EIRP, several options exist which can partially compensate for the losses. Let us discuss these options.

4.1.2.1 Reduce the bit rate [8]

Reducing the bit rate is a simple and efficient way to improve the link budget by gaining quickly some dB. E.g. dividing by a factor 2 the bitrate allows a gain of 3dB. This can be explained by the following:

$$\frac{e_b}{n_0} = \frac{C}{N} \frac{B}{f_b}$$

Where:

- $\frac{e_b}{n_0}$ is the Energy per bit to noise power spectral density ratio, which quantifies the link quality
- $\frac{C}{N}$ is the signal to noise ratio of a modulated signal
- f_b Is the bit rate
- B is the bandwidth

Thus, for a constant C/N and bandwidth, f_b divided by 2 translates to +3dB for the $\frac{e_b}{n_0}$

The counterpart of this action is a slower uplink transmission. The latter can become critical for activities requiring the upload of larger amounts of data, for example during software uploads.

DLR and GOMspace opted for this option and divided the uplink bit rate by a factor 4, resulting in a 6dB gain for the link quality.

4.1.2.2 Transmit at higher elevations

The biggest attenuation that affects a signal traveling between a spacecraft and a ground station is the free space loss, which is defined as follows [9]:

$$FSL = 10 \log \left(\frac{4\pi df}{c} \right)^2$$

where FSL is the free space loss in dB, d is the slant range between the transmitter and the receiver in m, f is the signal frequency in Hz, c is the speed of light in m.s-1

Now the slant range can be expressed as a function of the elevation angle at the ground station side through the following formula [10]:

$$d = R \left(\sqrt{\left(\frac{R+h}{R} \right)^2 - \cos^2 \alpha} - \sin \alpha \right)$$

where R is the Earth radius in meters, h is the altitude of the spacecraft in meters, and α is the elevation angle in degrees towards the spacecraft.

We consider an altitude of 550km and a frequency of 401 MHz for CubeL and we obtain the following FSL values:

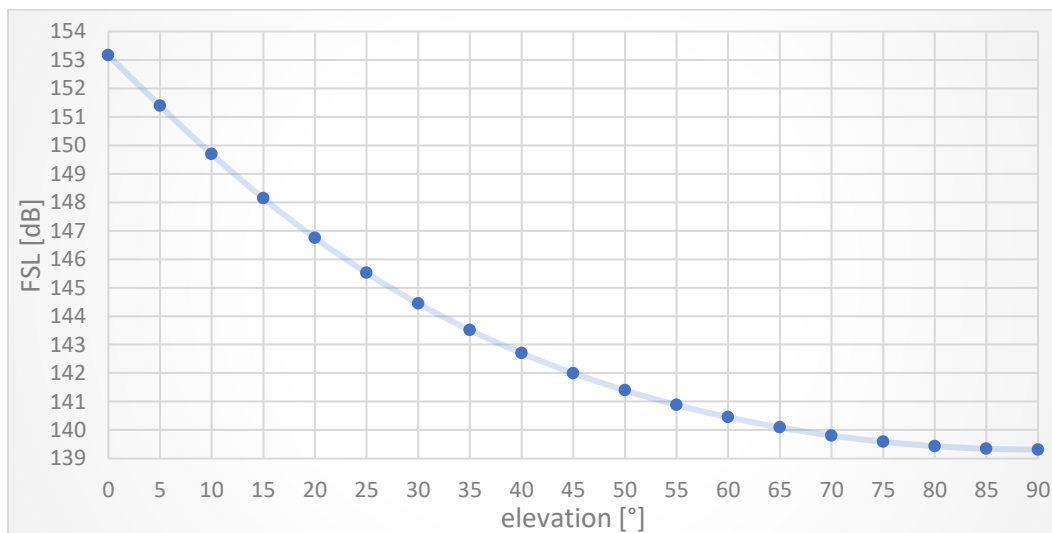

Fig. 5 Free space loss vs elevation for CubeL

Typical missions transmitting from 5° elevation, this leaves us a range in FSL of approximately 12dB until 90°, as Fig. 5 shows us. The trade-off takes place here between the required transmission time and the needed reduction in attenuation.

For the CubeL mission, the trade-off requires uplink from an elevation of 20°, which leads to a FSL reduction of 5dB and thus to a gain of 5dB on the link quality.

4.1.2.3 *More ways forward*

Of course, there are more options to improve the link. For example, one could opt for high coding gain or modify the on-board receiving system. Yet these options are typically more complicated and require a lot of complex hardware and/or software to be put in place. While on the ground, these could still be acceptable, this becomes unviable for on-board systems due to increasing space and energy consumption.

4.1.3 *Concluding on WRC-2019 impact*

Despite the terrible impact of WRC-2019 on our uplink, countermeasures to mitigate the loss of 22dB in the EIRP allowed us to gain back 11dB on the link budget, yet with two main impacts being the 4 times slower link and the loss of contact time.

4.2 *Evaluation of the UHF uplink*

Based on previous experience of the satellites' CSP nodes, primarily node 1 (On-Board computer) has been pinged. Several attempts had been made sending ping commands to node 5 (On-Board receiver) as well, however, node 1 has always shown a higher success rate. Since the OBC will receive a large portion of the operational commands, its responses are relevant.

For each session of the `csp_term` application (used for commanding the satellite) of a day, a log file is generated. This log file contains any ping commands that have been sent to the satellite including their responses. A response is either a timeout, which occurs if no reply has been received after a certain amount of time, or a reply directly from the satellite in combination with how long it took to respond.

Since the `csp_term` application does not log the time stamps of its contents, the timing of the ping commands cannot be extracted. Therefore, the overall percentage of successful ping commands is used as a metric for the quality of a pass. These are extracted from the log files via a script.

For some passes, it is known that the ping commanding started at 5 degrees elevation. Since the time of that event is known from the `csp_doppler` log (which does log time stamps in unix time), the sequence of ping commands can be re-created by a script based on the timeout or response times of each command. This allows for more insight into the behavior of the ping responses relative to azimuth and elevation.

The following questions were of interest:

- What is the effect of each parameter or a combination of parameters on the success of the ping commanding?
- Is the pointing of the UHF antenna as computed by the `csp_doppler` application (based on the TLE provided by the GSOC Flight Dynamics System) sufficiently accurate?
- Is the geographic alignment of the UHF antenna sufficiently accurate so that the computed pointing results in the correct actual pointing?

4.2.1 *Test Parameters*

Starting in August of 2021, several parameters of the UHF passes have been tracked. These can be used as independent variables against which to assess the success rates of ping commands sent to the satellite.

The following parameters are available:

- UHF Ground station transmitter power: The power with which the transmitter transmits to the satellite. Values of 7 dBW (low power), 29 dBW (high power) are possible. It is set directly at the antenna control by a hardware switch and is not logged. Note that when commanding with high power, the transmitter baud rate (see below) is usually set to 4800. This is logged by the `csp_doppler`, but is not a definitive indicator for high power having been used.
- UHF Ground station transmitter baud rate: The number of symbols sent to the satellite per second. Either 1200 1/s or 4800 1/s are used. It is configured in the `csp_doppler` application. Note that the rate set at the transmitter of the ground station must match that of the receiver of the satellite (and vice versa).

- **Satellite pointing:** Whether the satellite is in its pointing mode during the pass. Can either be True or False. The pointing is configured via a generated flight plan and uploaded to the satellite. So far, this has been done by GOMSpace with a flight plan provided by GSOC.
- **Azimuth offset:** A configurable offset in the csp_doppler application for the azimuth angle of the antenna. The application will apply this offset onto the computed azimuth angle based on the TLE. The log of the csp_doppler application will show the modified value.
- **TLE time offset:** A configurable offset in the csp_doppler application for the time. The application will compute a path consisting of azimuth and elevation angles which to follow at a certain time based on the TLE. The offset allows to advance or delay the movement of the antenna.

4.2.2 Test Results

4.2.2.1 Transmitter power and baud rate

Transmitting with high power shows a noticeable effect on the percentage of received responses as can be seen in Fig. 6. However, the mission is prohibited to use high power during nominal operations [7]. But even at high power, the success rate is not convincingly high enough to warrant routine operations. As of 2022-02-04, no attempt has been made to mix a high baud rate with low transmitter power. Therefore, the right side of the figure looks the same as the left. Such a test would be worthwhile to separate the effects of power and baud rate.

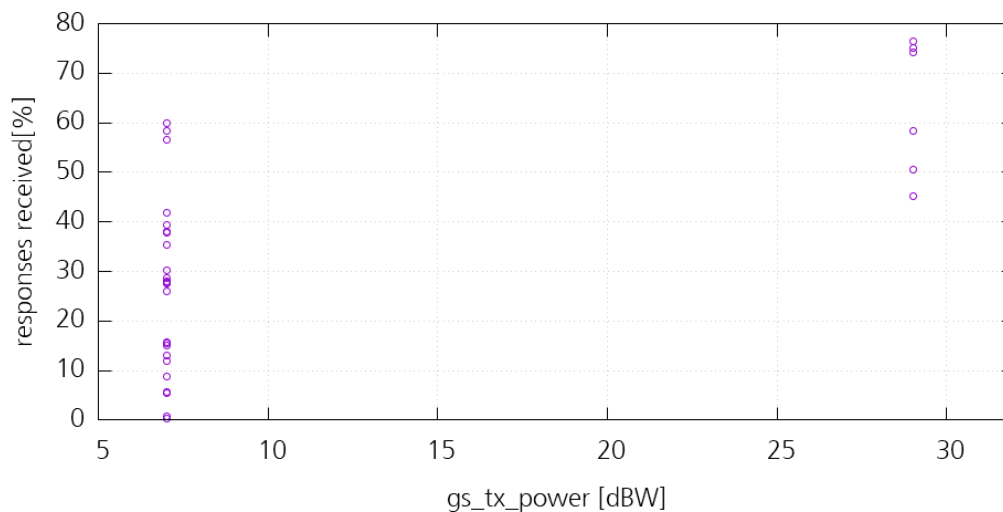

Fig. 6 Effect of the ground transmitter power on the success rate ping commands.

4.2.2.2 Antenna pointing

In Fig. 7, the effect of modifications to the antenna pointing can be seen. At first, a TLE offset of -2 seconds and then +5 seconds was attempted to investigate a potential misalignment of the antenna. In particular the 6 s offset shows a significant improvement, both for the low and high-power modes. In fact, the passes with the 6 s offset yielded the best results overall! The geometric measurements performed thereafter resulted in an offset of 3° in azimuth. This was expected to have the same effect by fixing a detected misalignment of the antenna. However, this was evidently not the case. The past five passes are all grouped together at quite low response rates of 12-16 %.

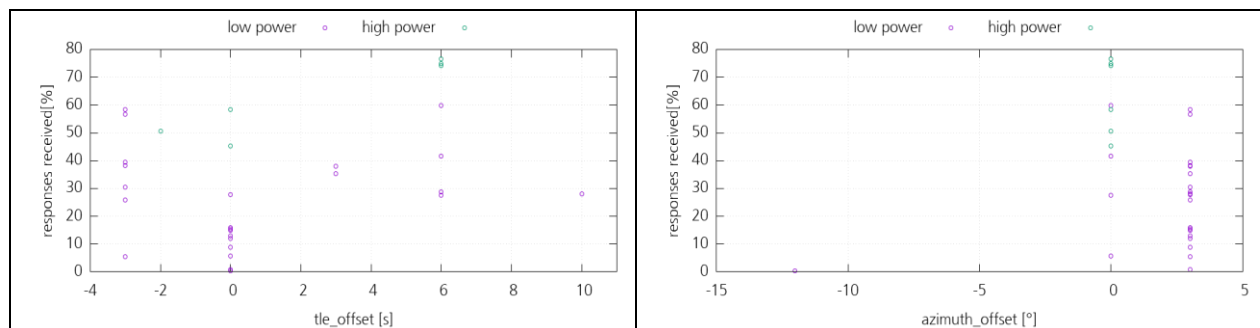

Fig. 7 Effect of TLE offset (left) and azimuth-offset (right). Note that the azimuth-offset was introduced to compensate for a slight geographic misalignment. The expectation was that this should yield similar results

4.2.2.3 Satellite pointing

Pointing of the satellite (a mode during which the satellite points its antenna to the ground station during a pass) has a positive effect on the success rate, but not decisively. Nonetheless, it is noteworthy that the highest success rate in low power with pointing was larger than the lowest success rate in high power without pointing.

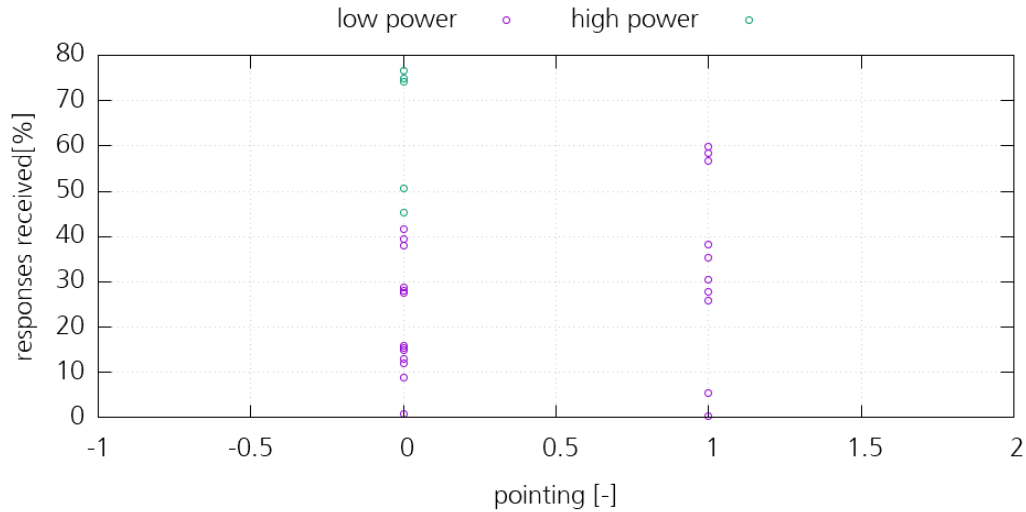

Fig. 8 Effect of satellite pointing.

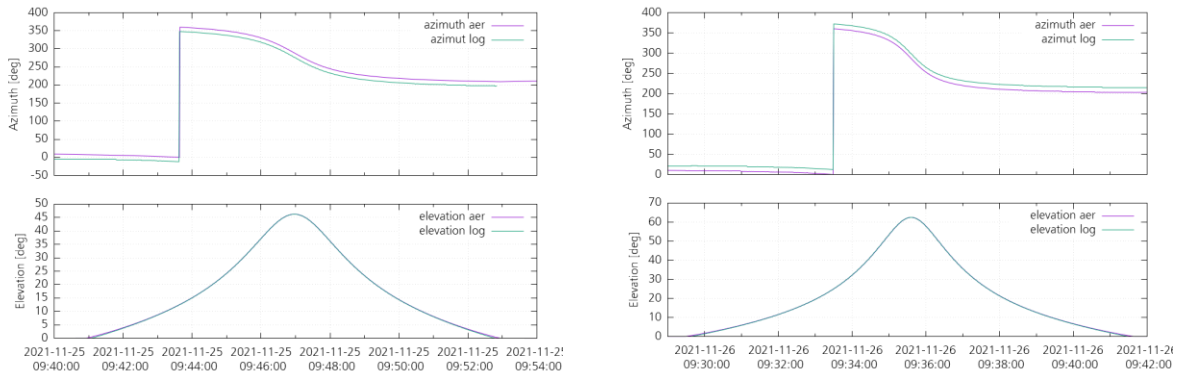

Fig. 9 Azimuth-offset of -12° (left) and +12° (right). In both cases, the followed azimuth and elevation is extremely close to the one computed by GSOCs Flight Dynamics System.

4.3 Antenna geometry

On one side, telemetry reception with the ground station was losing in quality. In parallel, the evaluation described in section 4.2.2.2 showed also bad signs on uplink quality. Both could quickly be linked to the antenna geometry as a probable root. A quick verification in situ confirmed this suspicion. In fact, in 2021, the antenna geometry happened to not respect anymore the original design. This is a normal fatigue for such antennas which need to be verified and readjusted at regular intervals, in our case biannually. Unfortunately, Covid-19 blocked us from doing so and as a consequence, we measured deltas of several degrees:

- between the desired azimuth and the true azimuth of the antenna
- between the desired elevation and the true elevation of the antenna
- in the parallelism of each cross-Yagi antenna

Readjusting the geometry of the ground station improved the quality of reception by less than 2 dB. This led us to the obvious conclusion that there was more than this geometry issue behind the link impairment.

4.4 Cable phasing

Despite the antenna geometry being corrected with the readjustments described in chapter 4.3, the link evaluation continued to highlight a larger problem since the amount of ping replies was still increasing for some specific time offset and azimuth offset values different from 0.

The UHF ground station transmitted polarization components were measured on the ground with the help of a signal generator connected to the antenna and a spectrum analyser connected to a log-periodic antenna. Fig. 10 below shows the results of this measurement:

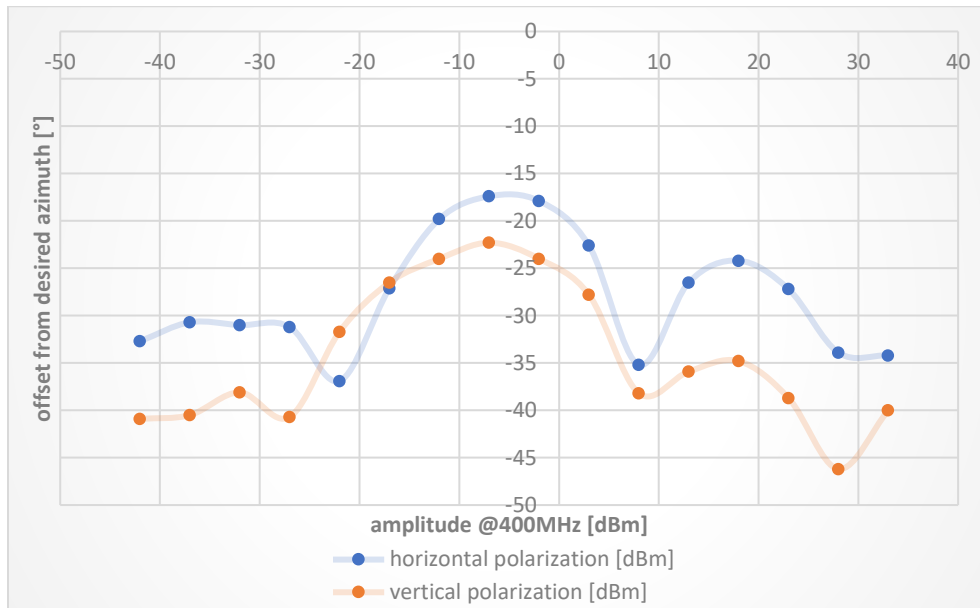

Fig. 10 Signal amplitude vs offset from desired azimuth

Clearly, we are forced to admit that there are still some misalignment at the antenna. Thus, phase delays and magnitude variations were evaluated between the two AX100 and the two cross-Yagi antennas. Fig. 11 describes the cabling between AX100s and antennas.

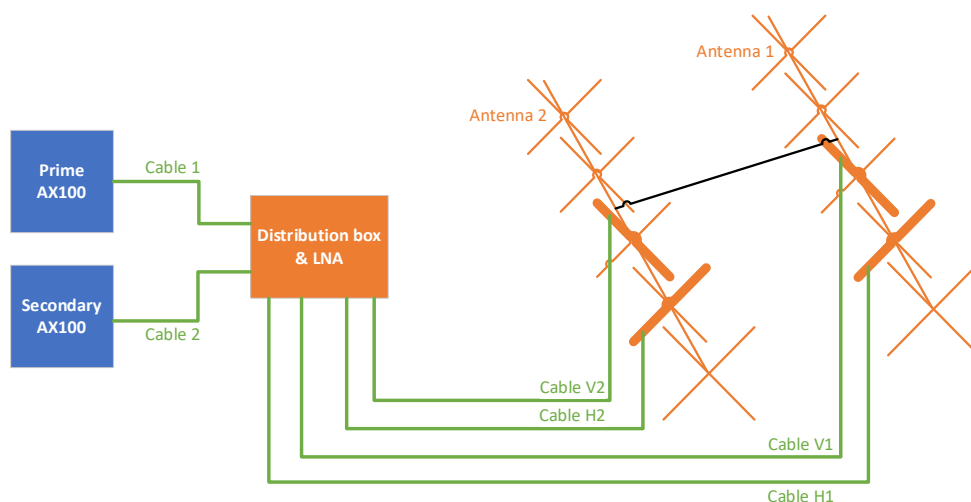

Fig. 11 RF cabling between GS100 and AS100

To measure the phase delays and magnitude variations, we used a Rohde&Schwarz FSH3 hand-held spectrum analyser and its internal tracking generator. We used a reference cable loop and measured the initial phase delay and attenuation of this loop. Then we inserted in this loop the components which we wanted to verify. Results are shown in Table 2 and Table 3:

Magnitude variations @ f= 400MHz measured [dB]	H1	V1	H2	V2
at cable to box input 1 (reference)	0			
after cable from distrib. box output to dipole	-7,9	-8,1	-8,1	-8,0
at cable to box input 2 (reference)	0			
after cable from distrib. box output to dipole	-7,9	-7,9	-8,2	-7,9
<i>1-2 attenuation delta measured</i>	<i>0</i>	<i>0,2</i>	<i>-0,1</i>	<i>0,1</i>

Note: Attenuations in cable 1 and cable 2 were comparable (< 1dB difference)

Table 2 Magnitude variations measurements

From Table 2, we conclude that attenuations are identical in our system and cannot cause problems to our UHF link with CubeL.

Phase delays @ f= 400MHz measured [°]	H1	V1	H2	V2
at cable to box input 1 (reference)	0			
at distrib. box output	-65	-152	-59,5	-150,5
<i>H-V delta measured</i>	<i>87</i>		<i>91</i>	
<i>1-2 polarization delta measured</i>	<i>5,5</i>	<i>1,5</i>		
after cable from distrib. box output to dipole	-116,6	-115,9	-134,3	-124,2
resulting phase delay after dipole cable end	-181,6	-267,9	-193,8	-274,7
<i>H-V delta measured</i>	<i>86,3</i>		<i>80,9</i>	
<i>1-2 polarization delta measured</i>	<i>-12,2</i>	<i>-6,8</i>		

Note: Phase delays in cable 1 and cable 2 were comparable (< 10° difference)

Table 3 Phase delay measurements

Due to the precision of the measurements, polarization deltas should be neglected when less than 15° from their expected values. From Table 3, we conclude that:

- The difference between the left and right antennas is within the limits ($0^\circ \pm 15^\circ$ for both polarizations).
- The difference between the horizontal and vertical components reach the expected value ($90^\circ \pm 15^\circ$).

Thus, phase delays and magnitude variations obtained seem acceptable. Assuming that the 4 dipoles are identical, the uplink signals should be almost perfectly circular and the downlink signals should be decomposed almost perfectly into their horizontal and vertical components.

Unless...

The problem lies again in the geometry of the antenna, but this time, in the location of the dipoles on each antenna boom. If you look closely at Fig. 3 and Fig. 11, you can see that dipoles are not superposed but away from each other. Let us measure this:

distance between horizontal and vertical dipoles		
antenna 1	257	mm
antenna 2	255	mm
CubeL wavelength	745	mm
ratio	0,345	~1/3

Table 4 Distance between horizontal and vertical dipoles compared to CubeL wavelength

Table 4 highlights that signals radiated after the cables H1 and H2 should have a phase offset of 120° with the signals radiated after the cables V1 and V2 (in addition to the 90° offset for generating the circular polarization). But Table 3 clearly shows that the H-V deltas are close to 90°.

This missing 120° offset resulted in the uplink signal transmitted with an inverted and highly elliptical polarization compared to the desired signal. Also, the reception of the downlink signal was impacted. This issue was solved with the help of the furnisher who provided us a new set of cables with the correct compensation. After switching the cables, we obtain the following results:

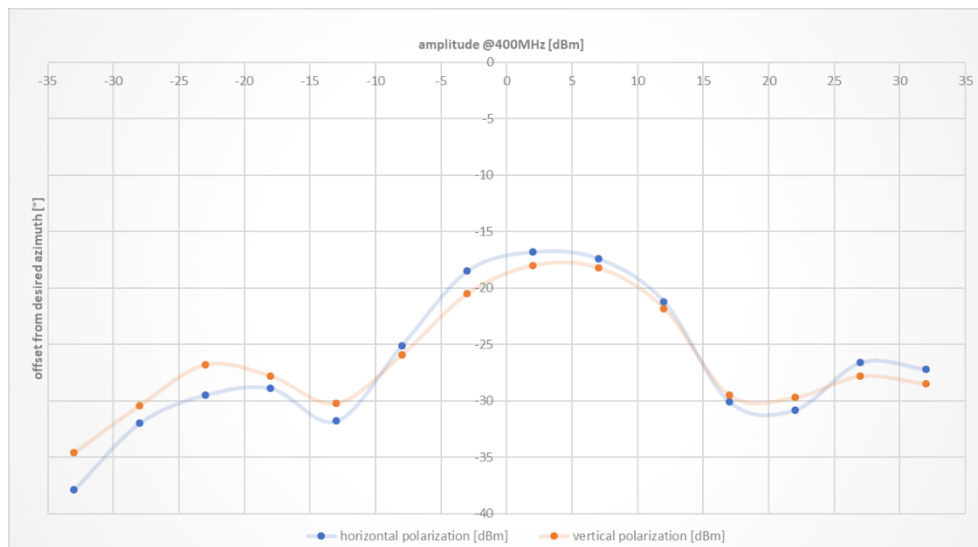

Fig. 12 Signal amplitude vs offset from desired azimuth after correction of phase misalignment

While still showing a small offset in the azimuth, potentially due to the limited precision of the measurements in azimuth, both horizontal and vertical components of the uplink have similar amplitudes. This confirms that the uplink signal polarisation is now circular again.

5. Lessons learned

As seen in section 4, the UHF link was impacted not only by a single issue, but by a product of issues having various origins, from new regulations to absence of maintenance due to Covid-19 pandemic. To identify and monitor these issues, a new method was developed, which uses the overall percentage of successful ping commands as a metric to estimate for the quality of a pass. This method has several advantages. It is simple to put in place. This method is monitoring both up- and downlink over the entire pass. And this gives us an idea of the link quality despite the usage of PLOP-1 [11] on our UHF uplink (intermittent uplink signal over the pass). Thus, using this ping method with different variables helped us tremendously in characterizing our link and in hinting us towards the roots of several issues. Limitation of the ping method are also clear. It consumes spacecraft contact time, since no other command can be sent during this time. And monitoring both up- and downlink together bring uncertainty in finding the roots of problems. If we do not receive the ping reply, is the ping request lost before reaching the spacecraft? Is the spacecraft capable of processing the ping request? Is the ping reply lost before reaching the ground station? Hence, this uncertainty limits the accuracy of this method.

Using the ping method combined with on-site verifications, one issue root was identified in the antenna geometry. This highlighted that the antenna geometry shall be controlled regularly, even in times of pandemic, to secure a good link quality. Note that the impact of this root cause was limited to a few dB loss only.

The ping method also hinted us on the phase misalignment. This was confirmed by measurement techniques in situ. If probably caused by a mistake in the delivery of the AS100 components (wrong cables from distribution box to dipoles), the phase misalignment could have also been prevented by a better inspection at delivery and mounting of the AS100 on our side. Our responsive partner GOMspace corrected the cables as soon as the fault was identified and thus the issue could be resolved.

On top of the issues already encountered, WRC-2019 had a serious negative impact on our uplink. Mitigation actions like lowering the bit rate allowed us to limit somewhat the disaster. On one side, the high power configuration (29dBW EIRP, non WRC-2019 compliant) with a non-pointing spacecraft returns good uplink statistics with ping replies up to 80% of contact times. This validates the link budget analysis and the design of GOMspace for this configuration. On the other side, the low power configuration (7dBW EIRP, WRC-2019 compliant) with a pointing spacecraft and a 4 times smaller bit rate struggles to achieve in average 40% ping replies (non-pointing achieves an average of 20%). It is important to note at this point that such configurations could have easily been evaluated and validated during a Radio Frequency compatibility Test (RFCT). But due to the Covid-19 pandemic, the RFCT could not take place.

In the end, the correction of geometry- and phase-related issues along with the WRC-2019 mitigation actions improved strongly the downlink reception quality and improved the uplink quality.

6. Conclusion

In the process of evaluating and improving the CubeL communications, the ping method helped us a lot in the narrowing down the origins of the existing issues. Following this step, corrections and mitigation actions could be identified with the help of further techniques and applied to improve the links. This entire process was only possible with the constant and responsive help of GOMspace. One of their substantial helps was to take over UHF operations. Following the actions taken, we conclude that at this point for CubeL:

- The downlink is fully operational with a stable and reliable telemetry reception
- The uplink in the non WRC-2019 compliant configuration could support nominal operational if WRC was allowing, with this link being reasonably stable and reliable
- The uplink in the WRC-2019 compliant configuration is currently not capable to support nominal operations. It reaches with difficulty the spacecraft and on top of this the communication is slowed down due to the lower bit rate. Further actions will be needed to compensate the EIRP loss before having this link fully operational.

With the help of the CubeL manufacturer, we look forward to progressing towards the fully operational WRC-2019 compliant communication system. For this, we will continue using the ping measurement method to monitor our link with CubeL and to identify issues, along with further work on the ground.

Acknowledgements

The authors would like to thank all the colleagues of the CubeL team, both at GOMspace and at DLR, who keep helping us along this path towards the UHF nominal operations. A special thanks goes to the colleagues from DLR Institute for Communication and Navigation, Institute of Robotics and Mechatronics and Earth Observation Center for their extensive support of our testing activities.

References

- [1] European Space Agency, "eoPortal - Satellite Missions Catalogue," February 2021. [Online]. Available: <https://www.eoportal.org/satellite-missions/pixl-1>. [Accessed 23 01 2023].
- [2] E. Kulu, "Nanosats Database - PIXL-1," 29 12 2022. [Online]. Available: <https://www.nanosats.eu/sat/pixl-1>. [Accessed 21 01 2023].
- [3] GOMspace, "NanoCom AS100 Datasheet - UHF antenna tower for communication with LEO satellites," 2018. [Online]. Available: <https://gomspace.com/shop/subsystems/ground-systems/nanocom-as100.aspx>. [Accessed 18 12 2020].
- [4] GOMspace, "NanoCom GS100 Datasheet - Dual-radio ground station solution for NanoCom AX100," 2020. [Online]. Available: <https://gomspace.com/shop/subsystems/ground-systems/nanocom-gs100.aspx>. [Accessed 19 01 2023].

- [5] GOMspace, "NanoCom AX100 Datasheet - Long-range software configurable VHF/UHF transceiver," 2019. [Online]. Available: <https://gomspace.com/shop/subsystems/communication-systems/nanocom-ax100.aspx>. [Accessed 13 12 2022].
- [6] GOMspace, "NanoCom MS100 Datasheet - Ground station computer with satellite control software," 2021. [Online]. Available: <https://gomspace.com/shop/subsystems/ground-systems/nanocom-ms100.aspx>. [Accessed 19 01 2023].
- [7] International Telecommunication Union (ITU), "World Radiocommunication Conference 2019 (WRC-19) - Final Acts, Sharm El-Sheikh," 2020. [Online]. Available: <https://www.itu.int/pub/R-ACT-WRC.14-2019/en>. [Accessed 17 01 2023].
- [8] J. Pearce, "Spread Spectrum Scene - Eb/N0 Explained," 09 06 2014. [Online]. Available: <http://www.sss-mag.com/ebn0.html>. [Accessed 11 01 2023].
- [9] D. Roddy, Satellite communications, New York: McGraw Hill, 2006.
- [10] S. Cakaj, M. Fitzmaurice, J. Reich and E. Foster, "The Downlink Adjacent Interference for Low Earth Orbiting (LEO) Search and Rescue Satellites," International Journal of Communications, Network and System Sciences, Vol. 3 No. 2, pp. 107-115, 2010.
- [11] CCSDS, "Recommended Standard for TC Synchronization and Channel Coding CCSDS 231.0-B-4," July 2021. [Online]. Available: <https://public.ccsds.org/Pubs/231x0b4e0.pdf>. [Accessed 19 01 2023].